

Submittal Data: VIR09HP230V1B 9,000 BTU/H (208/230V) Wall Mounted Heat- Pump System

Job Name	Location	Date
Purchaser	Engineer	
Submitted To	For	<input type="checkbox"/> Reference <input type="checkbox"/> Approval <input type="checkbox"/> Construction
Unit Designation	Schedule No.	

- GENERAL FEATURES**
- Compact and Quiet Design
 - High Efficiency DC Inverter Technology
 - Wireless Remote with LCD Display
 - Wi-Fi Ready (Sold Separately Kit PN: WSBE02)
 - XK-41 Wired Tether Controller (Sold Separately)
 - Low Ambient Cool to 0 deg F
 - Blue Fin Condenser Coil
 - 5 year Limited Parts Warranty



System Ratings

Cooling	
Rated Capacity	9,000 BTU/H
Capacity Range	3,100-9,600 BTU/H
Power Input (Max)	1,300 W
SEER	23.0
EER	14.0
Heating at 47° F	
Rated Capacity	11,000 BTU/H
Capacity Range	1,911-12,000 BTU/H
Power Input (Max)	1,350 W
HSPF	10.5
COP	3.2
Heating at 17° F	
Rated Capacity	6,800 BTU/H
Operating Range	
Cooling (Max)	115°F (46 C)
(Min)	0°F (-18 C)
Heating (Max)	75°F (24 C)
(Min)	-4°F (-20 C)

Indoor Unit Data

Fan Motor	Type	Cross-Flow
	Output Power	20 W
	FLA	0.1 A
Airflow		
Cooling Wet (Lo/Hi)		171/377 CFM
Heating Dry (Lo/Hi)		171/377 CFM
Sound Pressure Level		
Cooling (Min/Max)		29/43 db(A)
Heating (Min/Max)		29/43 db(A)
Dehumidification		1.69 pt/hr

Refrigerant Piping Data

Gas Pipe Size (OD)	3/8-in
Liquid Pipe Size (OD)	1/4-in
Connection Method	Flared
Factory Charge	45.9 oz
Additional Charge	0.16 oz/ft
Pre-Charge Length	25-ft
MAX Refrigerant Pipe Length	49-ft
MIN Refrigerant Pipe Length	10-ft
MAX Refrigerant Pipe Elevation	33-ft

Outdoor Unit Data

Compressor	Type	DC Inverter Driven Rotary
	RLA	6.6 A
Refrigerant Type		R410A
Fan Motor	Output Power	30 W
	FLA	0.36 A
Sound Pressure		
Cooling/Heating		53/53 db(A)

Electrical Data

Power Supply		
Normal Operational Voltage		208/230 V, 1 Phase, 60 Hz
Voltage Range		187 - 253 V
MCA		9.0 A
MOCP/Breaker Size		15 A
Main Power Wire Size		14-2 AWG

SYSTEM FEATURES	
Inverter Type	G10
Ultra Low Frequency Torque Control	Yes
Power Factor Correction	Yes
Compressor Type	High Eff. Rotary
Refrigerant Type	R410A
Basepan With Electric Heater	NO
Compressor With Electric Heater	YES
Outdoor Fin Coating	Bule Fin
Intelligent Defrosting	YES
Intelligent Preheating	YES
Low Voltage Startup	YES
Memory/Power Failure Recovery	YES
Self Diagnosis	YES
Wired Controller Interface (XK-41)	YES
Wi-Fi Interface Capable	Optional (see PN: WSBEC01)
Indoor Fan Type	Crossflow
Multi Fan Speeds	4 Speeds
Indoor Unit Display	YES
Advance Filter	Optional (see Filter Kits)
Auxiliary Electrical Heater	NO
Ventilation (Outdoor Air)	NO

REMOTE CONTROLLER FUNCTIONS	
Auto Mode	YES
Auto Fan	YES
Auto Swing (Horizontal Auto Swing)	NO
Auto Swing (Vertical Auto Swing)	YES
Clock on Remote Controller	YES
Dry Mode	YES
Dry Anti-Mildew (X-Fan) Mode	NO
Energy Saving Mode	YES
Dirty Filter Alert	NO
I Feel Function	YES
Lock on Remote Controller	YES
Quiet Mode	NO
Room Temperature Display	YES
Sleep Mode	YES
4 Sleep Modes Options	NO
Timer Mode	YES
Turbo Mode	YES
Display On/Off Control	YES
Freeze Guard Mode	YES
Display On/Off Control	YES
Freeze Guard Mode	YES

COOLING PERFORMANCE (BtuH)*

Outdoor Ambient DB	Indoor Ambient Temperature							
	68F DB (20C)		73F DB (23C)		80F DB (27C)		82F DB (28C)	
	57F WB (14C)		61F WB (16C)		67F WB (19C)		68F WB (20C)	
	TC	SHC	TC	SHC	TC	SHC	TC	SHC
5°F	5,748	4,508	6,073	4,761	6,854	5,375	6,914	5,423
14°F	5,896	4,624	6,226	4,883	7,115	5,579	7,178	5,629
23°F	6,298	4,940	6,736	5,284	7,719	6,054	7,787	6,108
32°F	7,637	5,990	8,169	6,407	8,947	7,015	9,026	7,077
41°F	8,650	6,784	9,190	7,207	9,821	7,703	9,908	7,771
50°F	8,547	6,705	9,091	7,131	9,731	7,633	9,817	7,700
59°F	8,337	6,538	8,878	6,963	9,641	7,563	9,726	7,630
68°F	8,127	6,373	8,668	6,799	9,461	7,420	9,545	7,486
77°F	7,920	6,212	8,457	6,632	9,280	7,280	9,363	7,344
86°F	7,692	6,033	8,229	6,452	9,010	7,067	9,090	7,130
95°F	7,505	5,887	8,040	6,306	8,893	6,976	8,972	7,038
104°F	7,319	5,740	7,854	6,160	8,776	6,884	8,854	6,945
113°F	6,944	5,445	7,478	5,865	8,403	6,589	8,478	6,648

HEATING PERFORMANCE (BtuH)*

Outdoor Ambient DB	Indoor Ambient Temperature							
	68F DB (20C)		73F DB (23C)		80F DB (27C)		86F DB (30C)	
	57F WB (14C)		61F WB (16C)		67F WB (19C)		72F WB (22C)	
	TC	SHC	TC	SHC	TC	SHC	TC	SHC
-4°F	5,772	5,772	5,717	5,717	5,620	5,620	5,393	5,393
0°F	6,253	6,253	6,194	6,194	6,091	6,091	5,840	5,840
6°F	6,597	6,597	6,535	6,535	6,425	6,425	6,160	6,160
10°F	6,872	6,872	6,806	6,806	6,693	6,693	6,418	6,418
16°F	7,078	7,078	7,013	7,013	6,896	6,896	6,610	6,610
19°F	7,219	7,219	7,147	7,147	7,030	7,030	6,738	6,738
24°F	8,020	8,020	7,951	7,951	7,831	7,831	7,542	7,542
32°F	8,955	8,955	8,886	8,886	8,766	8,766	8,477	8,477
41°F	10,024	10,024	9,955	9,955	9,838	9,838	9,546	9,546
43°F	10,292	10,292	10,223	10,223	10,103	10,103	9,814	9,814
47°F	11,223	11,223	11,110	11,110	10,918	10,918	10,443	10,443
53°F	11,337	11,337	11,220	11,220	11,024	11,024	10,546	10,546
59°F	11,595	11,595	11,478	11,478	11,275	11,275	10,787	10,787
64°F	11,842	11,842	11,722	11,722	11,516	11,516	11,017	11,017
70°F	12066	12066	11942	11942	11736	11736	11227	11227
75°F	12234	12234	12110	12110	11897	11897	11382	11382

* Maximum system capacity

TC- Total Capacity (BtuH)

SHC- Sensible Capacity (BtuH)

MINIMUM SPACING REQUIREMENTS

Units: inch (mm)

INDOOR

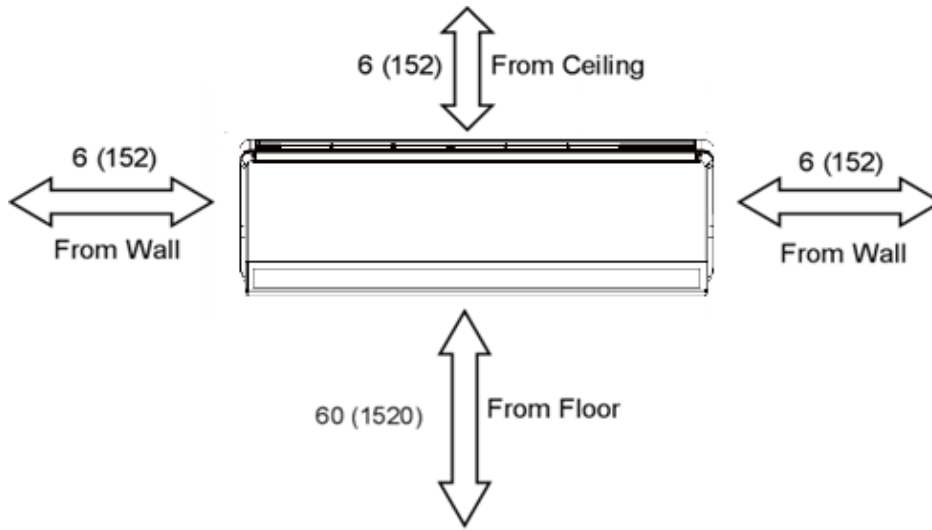

Units: inch (mm)

OUTDOOR

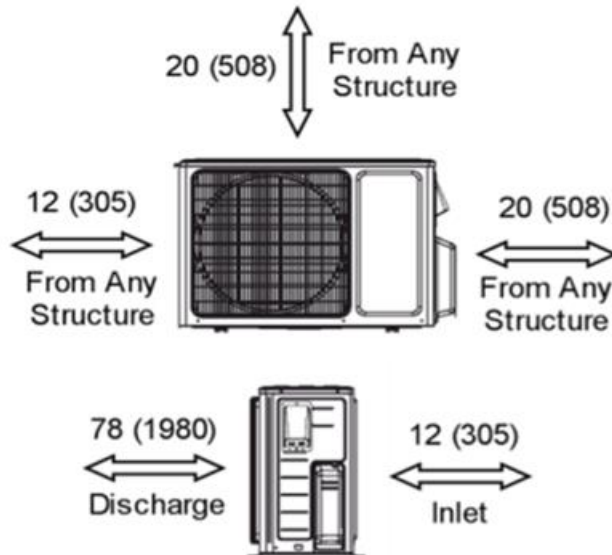

DIMENSIONAL SPECIFICATIONS

VIR09HP230V1B

INDOOR UNIT DIMENSIONS

Units: inch

Model No: VIR09HP230V1BH

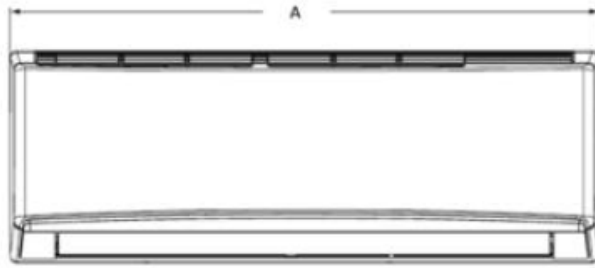

Dimensions	
A	33.4
B	11.4
C	8.2

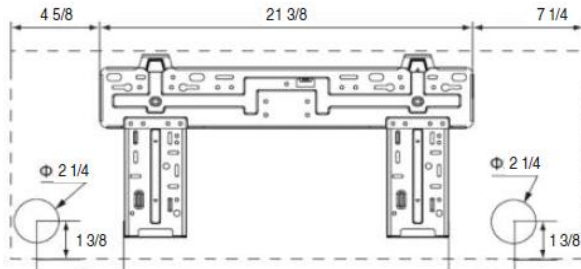

Weight (Net/Gross) 22.1/26.5 lbs

Liquid Line Valve	1/4-in OD Flared
Gas Line Valve	3/8-in OD Flared
Drain Connector	5/8-in OD

OUTDOOR UNIT DIMENSIONS

Units: inch

Model No: VIR09HP230V1BO

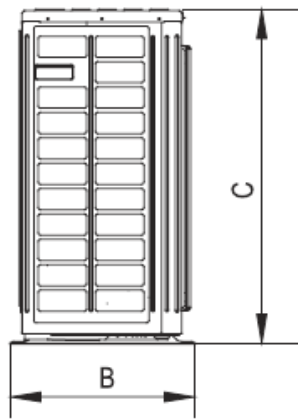
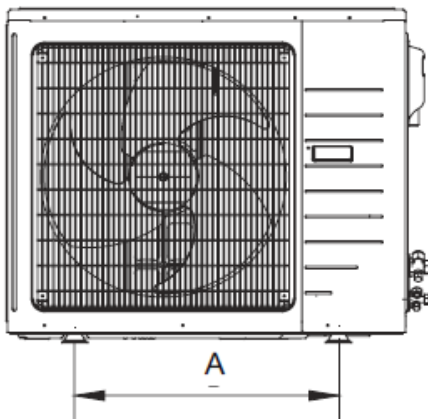

Dimensions	
A	21.3
B	12.6
C	21.3
D	33.4
E	11.3

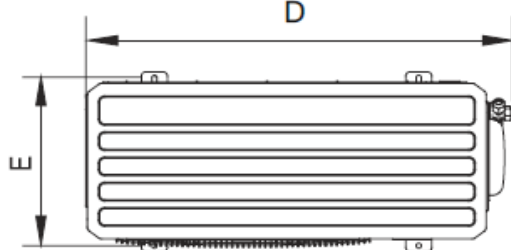

Weight (Net/Gross) 78.0/84.0 lbs

Liquid Line Valve	1/4-in OD Flared
Gas Line Valve	3/8-in OD Flared

Notes:

1. Recommended Interconnecting Cable Type 14 AWG-4 Stranded Copper Conductors THHN 600V Wire
2. Power wiring cable size must comply with applicable national and local codes.
3. Test conditions are based on AHRI 210/240.

Specifications are subject to change without notice. Manufacturer reserves the right to discontinue or modify specifications or designs without notice or without incurring obligations. All rights reserved.