

Job Name:

System Reference:

Date:

Indoor Unit:
MSZ-GL09NA



Wireless Remote Controller



GENERAL FEATURES

- Slim wall-mounted indoor units provide zone comfort control
- The outdoor unit powers the indoor unit, and should a power outage occur, the system is automatically restarted when power returns
- Multiple fan speed options: Quiet, Low, Medium, High, Super-high, Auto
- Multiple control options available:
 - Hand-held Remote Controller (provided with unit)
 - kumo cloud® smart device app for remote access
 - Third-party interface options
 - Wired or wireless controllers
- Hot-Start Technology: no cold air rush at equipment startup or when restarting after Defrost Cycle
- Quiet operation
- Smart Set: recalls a preferred preset temperature setting at the touch of a button

SPECIFICATIONS: MSZ-GL09NA

Cooling Capacity ^{1, 3}		BTU/H	9,000
Heating Capacity ^{2, 3}		BTU/H	10,900
Electrical	Voltage, Phase, Frequency		208/230V, 1 phase, 60Hz
	Guaranteed Voltage Range		V AC 187 - 253
	Voltage: Indoor - Outdoor, S1-S2		V AC 208 / 230
	Voltage: Indoor - Outdoor, S2-S3		V DC 24
	Short-circuit Current Rating (SCCR)		5
MCA		A	1
Blower Motor Full Load Amperage		A	0.76
Blower Motor Output		W	30
Airflow Rate at Cooling, Dry		CFM	399-321-237-170-145
Airflow Rate at Cooling, Wet		CFM	364-286-201-134-109
Airflow Rate at Heating, Dry		CFM	406-321-237-170-145
Sound Pressure Level (Cooling)		dB(A)	43-37-30-22-19
Sound Pressure Level (Heating)		dB(A)	43-37-30-22-19
Drain Pipe Size		In. (mm)	5/8 (15.88)
Heat Exchanger Type		Plate fin coil	
External Finish Color		Munsell 1.0Y 9.2/0.2	
Unit Dimensions	W: In. (mm)		31-7/16 (798)
	D: In. (mm)		9-1/8 (232)
	H: In. (mm)		11-5/8 (295)
Package Dimensions	W: In. (mm)		33-1/2 (850)
	D: In. (mm)		12 (300)
	H: In. (mm)		14 (350)
Unit Weight		Lbs. (kg)	22 (10)
Package Weight		Lbs. (kg)	26 (11.5)
Refrigerant	Type		R410A
Piping	Gas Pipe Size O.D. (Flared)		In. (mm) 3/8 (9.52)
	Liquid Pipe Size O.D. (Flared)		In. (mm) 1/4 (6.35)

Notes:

Nominal Conditions	¹ Cooling (Indoor // Outdoor)	°F	80 DB, 67 WB // 95 DB, 75 WB
	² Heating at 47°F (Indoor // Outdoor)	°F	70 DB, 60 WB // 47 DB, 43 WB

³Capacity varies based on the number of indoor units operating and the model of the Multi-zone Outdoor Unit. For reference to connected capacity charts, please refer Multi-zone Outdoor Unit Operational Performance.

ACCESSORIES: MSZ-GL09NA

Anti-allergy Enzyme Filter	□ MAC-408FT-E
kumo touch™ RedLINK™ Wireless Controller	□ MHK2
Deluxe MA Remote Controller ¹	□ PAR-40MAAU
Simple MA Controller ¹	□ PAC-YT53CRAU-J
Touch MA Controller ¹	□ PAR-CT01MAU-SB
Wired Remote Sensor	□ M21-EAA-307
Wireless Temperature and Humidity Sensor	□ PAC-USWHS003-TH-1
System Control Interface ²	□ MAC-334IF-E
Wireless Interface 2	□ PAC-USWHS002-WF-2
Thermostat Interface	□ PAC-US444CN-1
kumo station®	□ PAC-WHS01HC-E
USNAP Interface	□ PAC-WHS01UP-E
IT Extender	□ PAC-WHS01IE-E
BACnet® and MODBUS® Interface	□ PAC-UKPRC001-CN-1
Lockdown Bracket for Hand-held Remote Controllers	□ RCMKP1CB
Blue Diamond Sensor Extension Cable — 15 Ft.	□ C13-103
Blue Diamond Alarm Extension Cable — 6.5 Ft.	□ C13-192
Blue Diamond MultiTank — collection tank for use with multiple pumps	□ C21-014
Blue Diamond Rubber Foot Pads	□ F10-010
Mini Condensate Pump — 230 volt application	□ SI30-230
MegaBlue Advanced Blue Diamond Condensate Pump w/ Reservoir & Sensor	□ X87-835 - 110 to 250V
MaxiBlue Advanced Blue Diamond Mini Condensate Pump w/ Reservoir & Sensor (110V) up to 48,000 BTU/H[recommended]	□ X87-711 - 110V
Advanced Blue Diamond Mini Condensate Pump w/ Reservoir & Sensor (208/230V) [recommended]	□ X87-721 - 208/230V
MicroBlue Blue Diamond Mini Condensate Pump (110/208/230V) up to 18,000 BTU/H	□ X85-003
Fascia Kit for MicroBlue Pump – mounts the MicroBlue and sensor directly beneath the indoor unit	□ T18-016
Drain Pan Level Sensor	□ SS610E
(30A/600V/UL) [fits 2" X 4" utility box] - Black	□ TAZ-MS303
(30A/600V/UL) [fits 2" X 4" utility box] - White	□ TAZ-MS303W

¹ Requires MAC-334IF-E

² Allows indoor units to connect to an MA Controller

DIMENSIONS: MSZ-GL09NA

Unit: inch

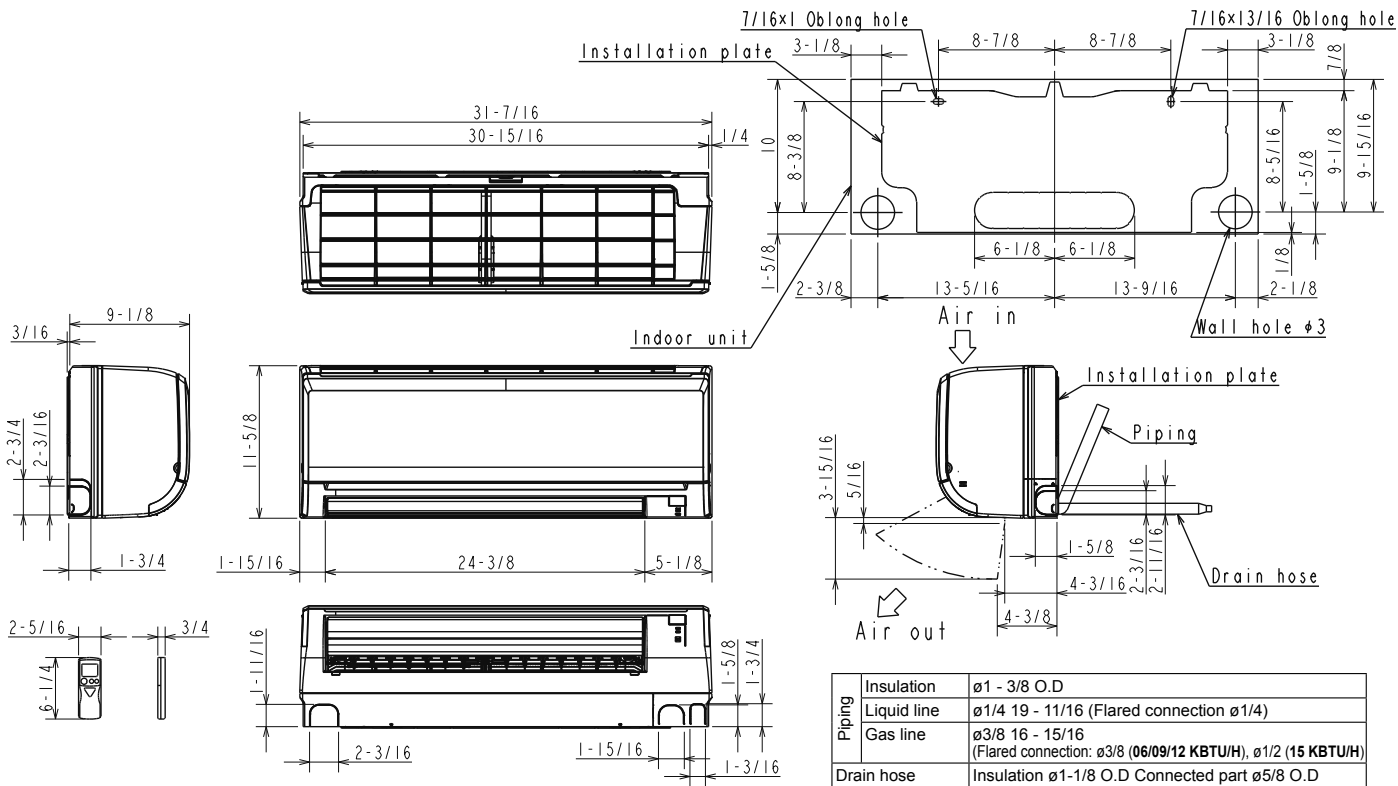

FORM# MSZ-GL09NA FOR MXZ-C MULTI-ZONE HEAT PUMP SYSTEMS - 202003

1340 Satellite Boulevard, Suwanee, GA 30024
Toll Free: 800-433-4822 www.mehvac.com



Specifications are subject to change without notice.

© 2020 Mitsubishi Electric Trane HVAC US LLC. All rights reserved.