

Submittal Data: LIVS09HP230V1B 9,000 BTU/H (208/230V) Wall Mounted Heat Pump System

Job Name _____ Location _____ Date _____

Purchaser _____ Engineer _____

 Submitted To _____ For Reference Approval Construction

Unit Designation _____ Schedule No. _____

- GENERAL FEATURES**
- High Efficiency DC Inverter Technology
 - Compact and Quiet Design
 - Wireless Remote with LCD Display
 - Wi-Fi Ready (Sold Separately Kit PN: WSBE02)
 - XK41 Wired Prog. Controller (Sold Separately)
 - Low Ambient Cool to 0 deg F
 - Blue Fin Condenser Coil
 - 5 year Limited Parts Warranty

System Ratings

Cooling		
Rated Capacity		9,000 BTU/H
Capacity Range		3,100-9,600 BTU/H
Power Input (Max)		900 W
SEER		16.0
EER		10.0
Heating at 47° F		
Rated Capacity		9,500 BTU/H
Capacity Range		3,100-12,000 BTU/H
Power Input (Max)		800 W
HSPF		9.0
COP		3.5
Heating at 17° F		
Rated Capacity		5,600 BTU/H
Operating Range		
Cooling	(Max)	115°F (46 C)
	(Min)	0°F (-18 C)
Heating	(Max)	75°F (24 C)
	(Min)	-4°F (-20 C)

Indoor Unit Data

Fan Motor	Type	Cross-Flow
	Output Power	20 W
	FLA	0.2 A
Airflow		
Cooling	Wet (Lo/Hi)	171/318 CFM
Heating	Dry (Lo/Hi)	171/318 CFM
Sound Pressure Level		
Cooling	(Min/Max)	28/43 db(A)
Heating	(Min/Max)	28/43 db(A)
Dehumidification		1.69 pt/hr

Refrigerant Piping Data

Gas Pipe Size (OD)	3/8-in
Liquid Pipe Size (OD)	1/4-in
Connection Method	Flared
Factory Charge	24.7 oz
Additional Charge	0.2 oz/ft
Pre-Charge Length	25-ft
MAX Refrigerant Pipe Length	49-ft
MIN Refrigerant Pipe Length	10-ft
MAX Refrigerant Pipe Elevation	33-ft

Outdoor Unit Data

Compressor	Type	DC Inverter Driven Rotary
	RLA	6.6 A
Refrigerant Type		R410A
Fan Motor	Output Power	30 W
	FLA	0.37 A
Sound Pressure	Cooling/Heating	52/52 db(A)

Electrical Data

Power Supply	
Normal Operational Voltage	208/230 V, 1 Phase, 60 Hz
Voltage Range	187 - 253 V
MCA	9.0 A
MOCP/Breaker Size	15 A
Main Power Wire Size	14-2 AWG

SYSTEM FEATURES	
Inverter Type	G10
Ultra Low Frequency Torque Control	Yes
Power Factor Correction	Yes
Compressor Type	High Eff. Rotary
Refrigerant Type	R410A
Basepan With Electric Heater	YES
Compressor With Electric Heater	YES
Outdoor Fin Coating	Blue Fin
Intelligent Defrosting	YES
Intelligent Preheating	YES
Low Voltage Startup	YES
Memory/Power Failure Recovery	YES
Self Diagnosis	YES
Wired Controller Interface (XK-41)	YES
Wi-Fi Interface Capable	Optional (see PN: WSBEC01)
Indoor Fan Type	Crossflow
Multi Fan Speeds	4 Speeds
Indoor Unit Display	YES
Advance Filter	Optional (see Filter Kits)
Auxiliary Electrical Heater	NO
Ventilation (Outdoor Air)	NO

REMOTE CONTROLLER FUNCTIONS	
Auto Mode	YES
Auto Fan	YES
Auto Swing (Horizontal Auto Swing)	NO
Auto Swing (Vertical Auto Swing)	YES
Clock on Remote Controller	YES
Dry Mode	YES
Dry Anti-Mildew (X-Fan) Mode	NO
Energy Saving Mode	YES
Dirty Filter Alert	NO
I Feel Function	YES
Lock on Remote Controller	YES
Quiet Mode	NO
Room Temperature Display	YES
Sleep Mode	YES
4 Sleep Modes Options	NO
Timer Mode	YES
Turbo Mode	YES
Display On/Off Control	YES
Freeze Guard Mode	YES
Display On/Off Control	YES
Freeze Guard Mode	YES

COOLING PERFORMANCE (BtuH)*

Outdoor Ambient DB	Indoor Ambient Temperature							
	68F DB (20C)		73F DB (23C)		80F DB (27C)		82F DB (28C)	
	57F WB (14C)		61F WB (16C)		67F WB (19C)		68F WB (20C)	
	TC	SHC	TC	SHC	TC	SHC	TC	SHC
0°F	5,675	4,451	5,996	4,700	6,723	5,274	6,783	5,320
5°F	5,748	4,508	6,073	4,761	6,854	5,375	6,914	5,423
14°F	5,896	4,624	6,226	4,883	7,115	5,579	7,178	5,629
23°F	6,298	4,940	6,736	5,284	7,719	6,054	7,787	6,108
32°F	7,637	5,990	8,169	6,407	8,947	7,015	9,026	7,077
41°F	8,650	6,784	9,190	7,207	9,821	7,703	9,908	7,771
50°F	8,547	6,705	9,091	7,131	9,731	7,633	9,817	7,700
59°F	8,337	6,538	8,878	6,963	9,641	7,563	9,726	7,630
68°F	8,127	6,373	8,668	6,799	9,461	7,420	9,545	7,486
77°F	7,920	6,212	8,457	6,632	9,280	7,280	9,363	7,344
86°F	7,692	6,033	8,229	6,452	9,010	7,067	9,090	7,130
95°F	7,505	5,887	8,040	6,306	8,893	6,976	8,972	7,038
104°F	7,319	5,740	7,854	6,160	8,776	6,884	8,854	6,945
113°F	6,944	5,445	7,478	5,865	8,403	6,589	8,478	6,648
115°F	6,923	5,429	7,448	5,842	8,371	6,564	8,445	6,622

HEATING PERFORMANCE (BtuH)*

Outdoor Ambient DB	Indoor Ambient Temperature							
	68F DB (20C)		73F DB (23C)		80F DB (27C)		86F DB (30C)	
	57F WB (14C)		61F WB (16C)		67F WB (19C)		72F WB (22C)	
	TC	SHC	TC	SHC	TC	SHC	TC	SHC
-4°F	4,985	4,985	4,937	4,937	4,854	4,854	4,658	4,658
0°F	5,400	5,400	5,350	5,350	5,261	5,261	5,044	5,044
6°F	5,697	5,697	5,644	5,644	5,549	5,549	5,320	5,320
10°F	5,935	5,935	5,878	5,878	5,780	5,780	5,543	5,543
16°F	6,113	6,113	6,056	6,056	5,955	5,955	5,709	5,709
19°F	6,234	6,234	6,172	6,172	6,071	6,071	5,819	5,819
24°F	6,926	6,926	6,867	6,867	6,763	6,763	6,513	6,513
32°F	7,734	7,734	7,674	7,674	7,570	7,570	7,321	7,321
41°F	8,657	8,657	8,598	8,598	8,497	8,497	8,244	8,244
43°F	8,888	8,888	8,829	8,829	8,725	8,725	8,476	8,476
47°F	9,693	9,693	9,595	9,595	9,429	9,429	9,019	9,019
53°F	9,791	9,791	9,690	9,690	9,521	9,521	9,108	9,108
59°F	10,014	10,014	9,913	9,913	9,738	9,738	9,316	9,316
64°F	10,227	10,227	10,123	10,123	9,945	9,945	9,515	9,515
70°F	10,420	10,420	10,313	10,313	10,135	10,135	9,696	9,696
75°F	10,566	10,566	10,459	10,459	10,275	10,275	9,830	9,830

* Maximum system capacity

TC- Total Capacity (BtuH)
 SHC- Sensible Capacity (BtuH)

MINIMUM SPACING REQUIREMENTS

Units: inch (mm)

INDOOR

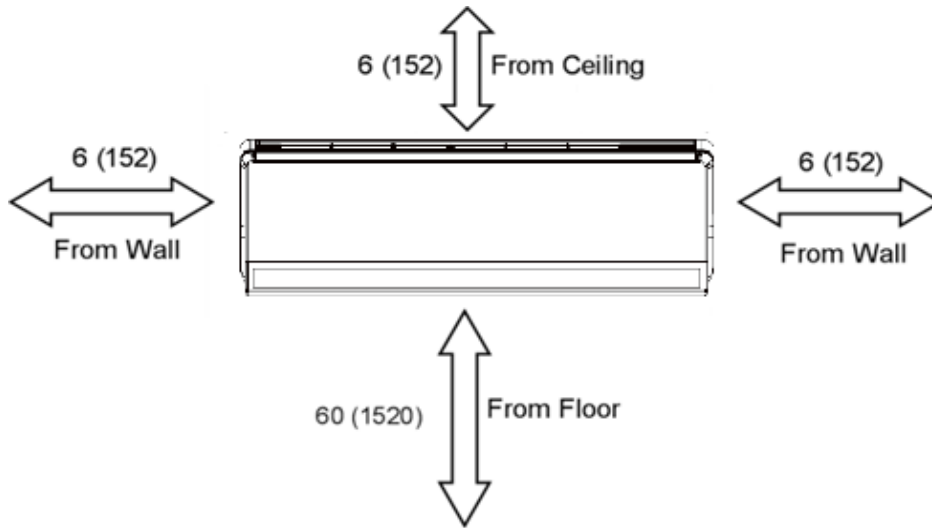

Units: inch (mm)

OUTDOOR

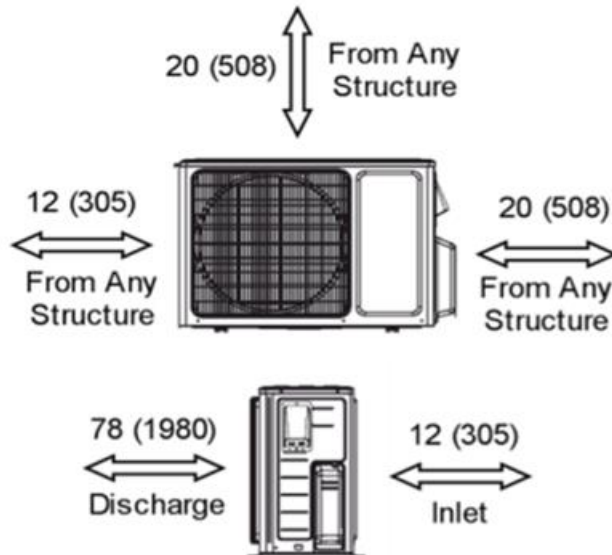

DIMENSIONAL SPECIFICATIONS

LIVS09HP230V1B

INDOOR UNIT DIMENSIONS

Units: inch

Model No: LIVS09HP230V1BH

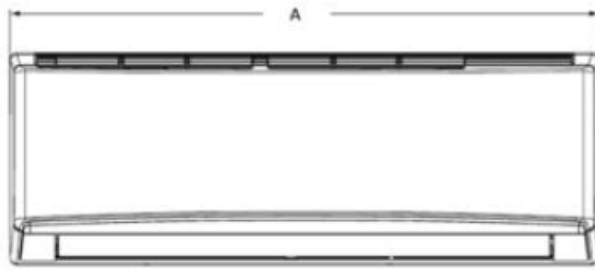

Dimensions	
A	31.1
B	10.8
C	7.9

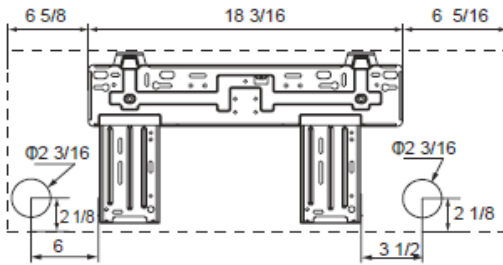

Weight (Net/Gross) 19.8/24.3 lbs

Liquid Line Valve	1/4-in OD Flared
Gas Line Valve	3/8-in OD Flared
Drain Connector	5/8-in OD

OUTDOOR UNIT DIMENSIONS

Units: inch

Model No: LIVS09HP230V1BO

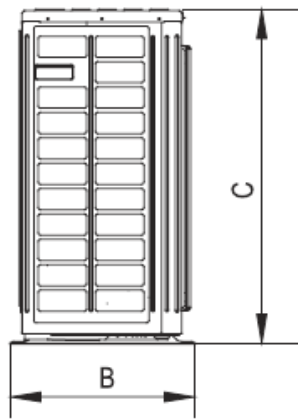
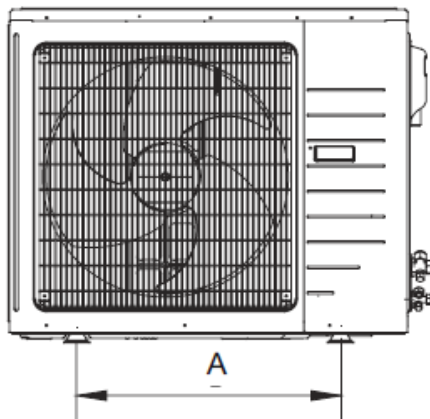

Dimensions	
A	20.0
B	12.6
C	21.3
D	33.6
E	11.3

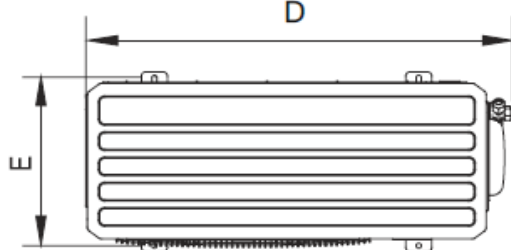

Weight (Net/Gross) 66.2/71.7 lbs

Liquid Line Valve	1/4-in OD Flared
Gas Line Valve	3/8-in OD Flared

Notes:

1. Recommended Interconnecting Cable Type 14 AWG 4 Stranded Copper Conductors THHN 600V Wire
2. Power wiring cable size must comply with applicable national and local codes.
3. Test conditions are based on AHRI 210/240.

Specifications are subject to change without notice. Manufacturer reserves the right to discontinue or modify specifications or designs without notice or without incurring obligations. All rights reserved.